



IBEX

IDAHO'S BEST EXTERIORS

TRIM & PANEL PROFILES

www.IBEXMETAL.com

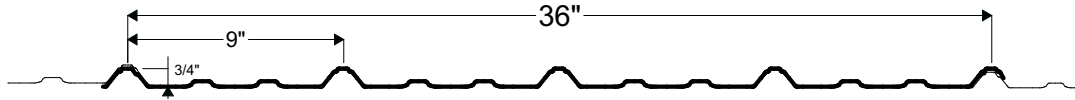

- Available with CONDENSTOP®
- No MIN or MAX length requirements
- 36" Coverage • 3/4" Rib Height
- Vented panel available
- 3:12 MIN recommended roof pitch
- 1:12 MIN pitch w/Seam Sealant

GR8/GR8WCS | TUFF-RIB (GR8)

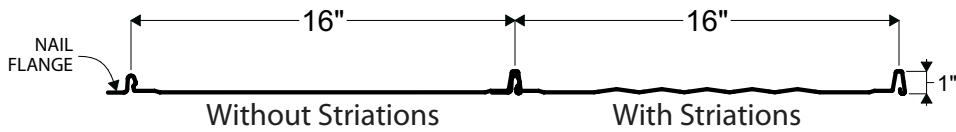

- Concealed Fastener
- No MIN or MAX length requirements
- Available as Pre-Notched Panel
- 3:12 MIN recommended roof pitch
- Striations recommended to reduce oil canning
- 16" Coverage • 1" Rib Height

SL1/SL1WS | SNAPLOCK PANEL 16

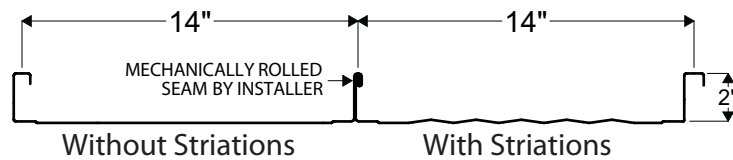

- Concealed Fastener
- No MIN or MAX length requirements
- 14" coverage • 2" Seam Height
- 2:12 MIN recommended roof pitch
- 1/2:12 MIN roof pitch w/Seam Sealant
- Striations recommended to reduce oil canning
- Requires Seamer Tool

SS/SSWS | STANDING SEAM

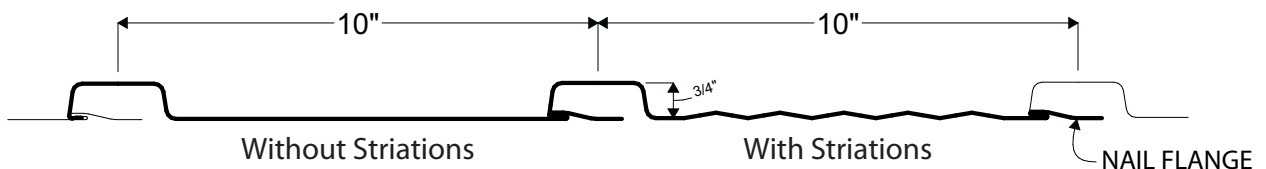

- Concealed Fastener
- 36 1/2" MIN Length
- Striations recommended to reduce oil canning
- 10" coverage • 3/4" Rib Height

BB/BBWS | BOARD & BATTEN PANEL

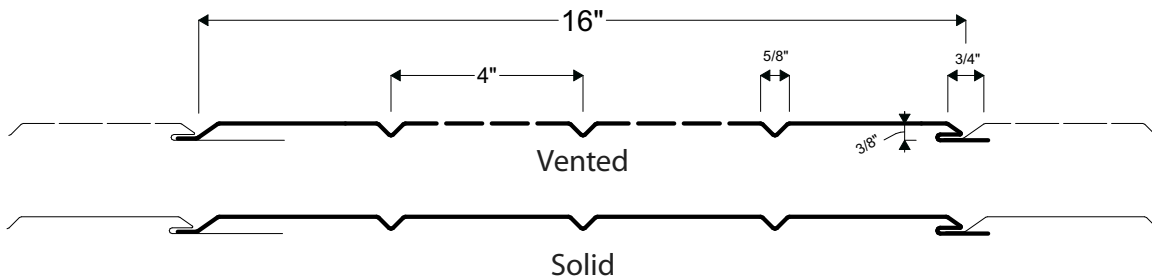

- Cut to Length
- 16" coverage
- 3/8" Height

SF/SFP | SOFFIT PANEL

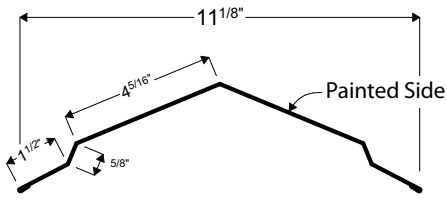

01 | RIDGE CAP

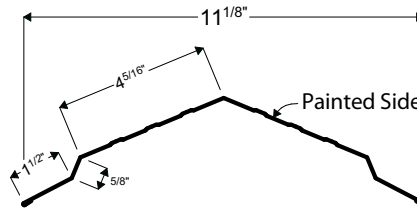

01R | RIDGE CAP - RIBBED

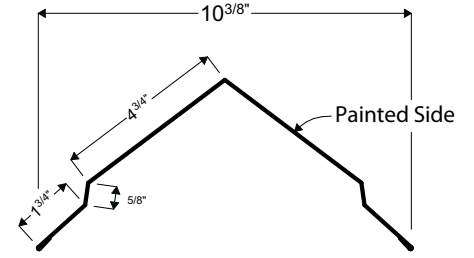

01C | RIDGE CAP (OVERSIZE 10/12)

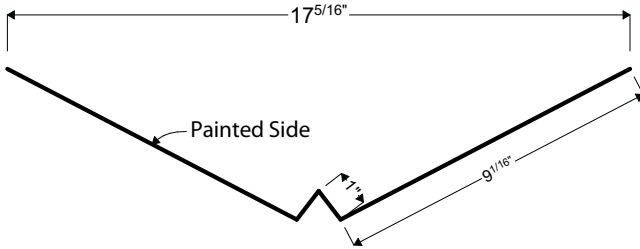

02 | VALLEY

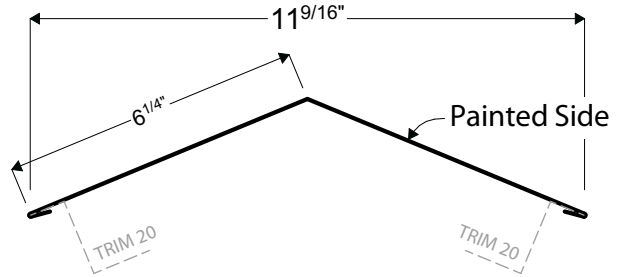

01B | RIDGE CAP - ARCHITECTURAL

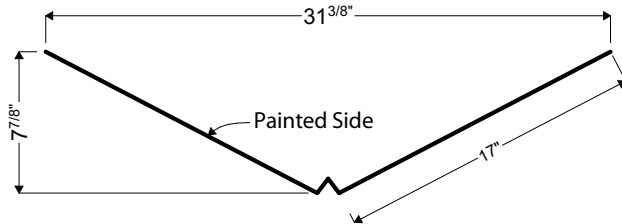

02B | JUMBO VALLEY

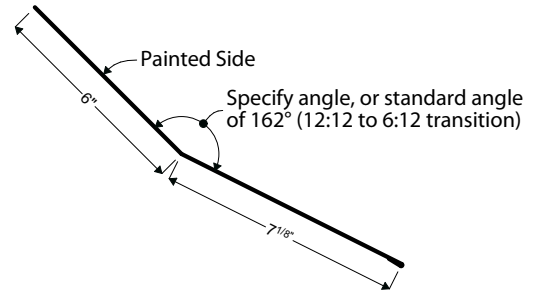

04 | PITCH BREAK (TRANSITION)

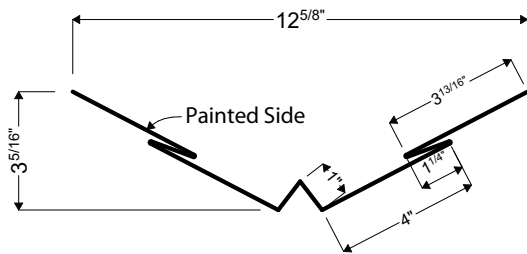

02C | CLEATED VALLEY

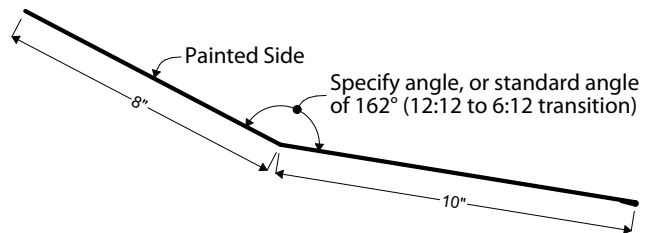

04B | JUMBO PITCH BREAK (TRANSITION)

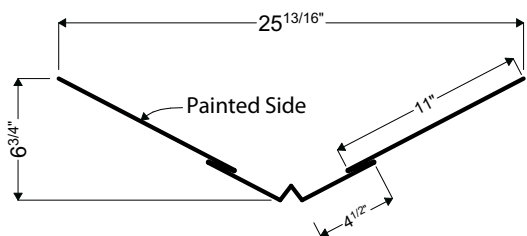

02D | JUMBO CLEATED VALLEY

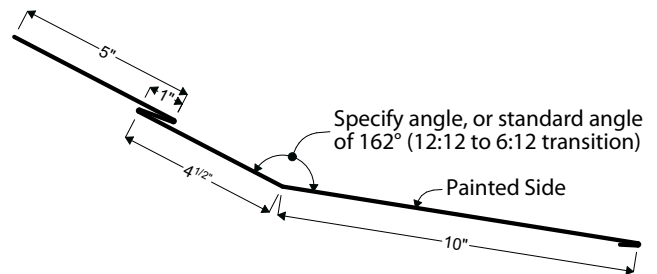

04G | CLEATED PITCH BREAK

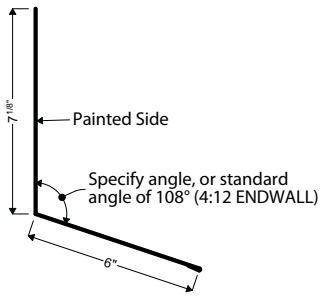

04C | ENDWALL

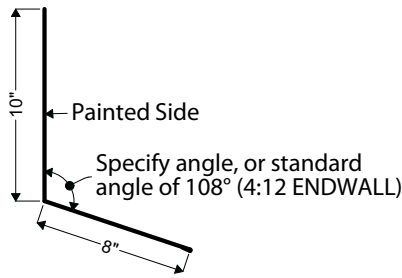

04D | JUMBO ENDWALL

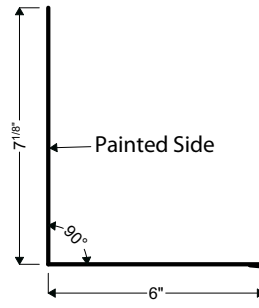

04E | SIDEWALL

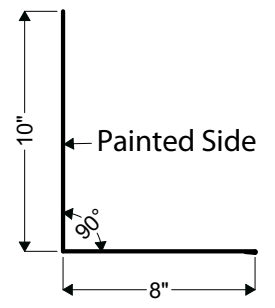

04F | JUMBO SIDEWALL

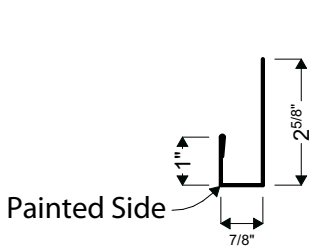

05 | J-CHANNEL

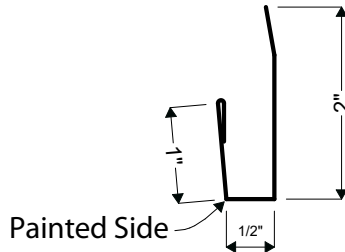

05B | MINI J-CHANNEL

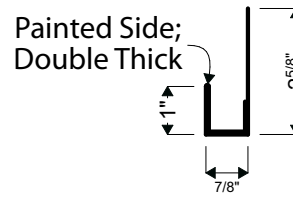

05C | FULL WRAP J-CHANNEL

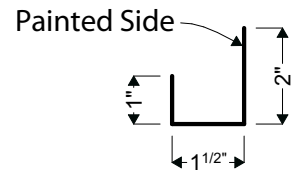

05D | REVERSE OVERSIZE J-CHANNEL

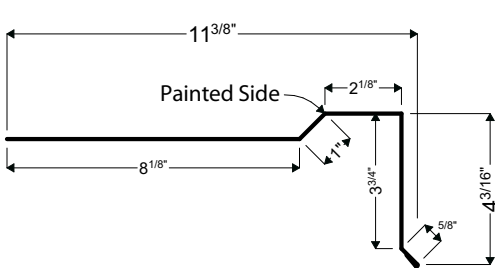

03 | PROW FLASHING

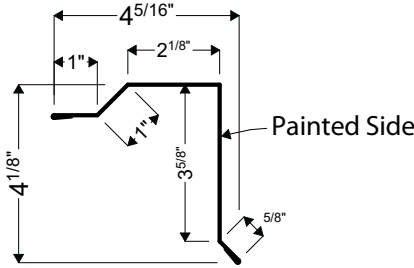

06 | MINI GABLE

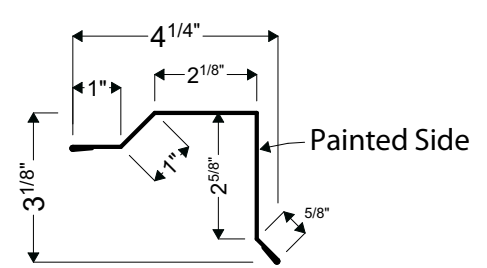

06B | MINI MINI GABLE

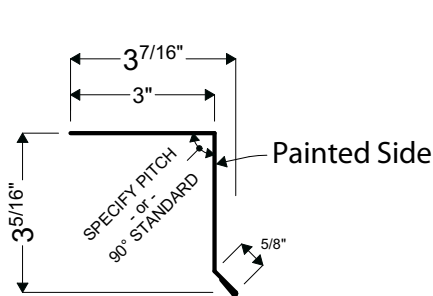

07 | MINI EAVE

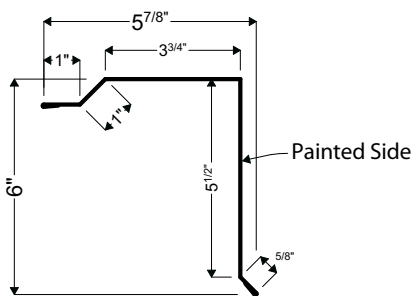

06C | OVERSIZED GABLE

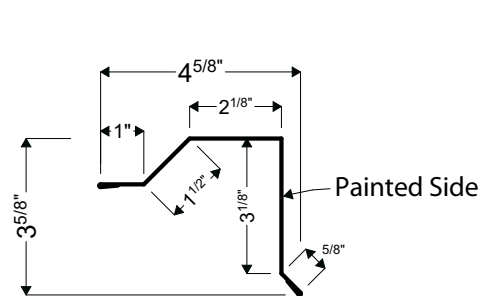

06E | STANDING SEAM GABLE

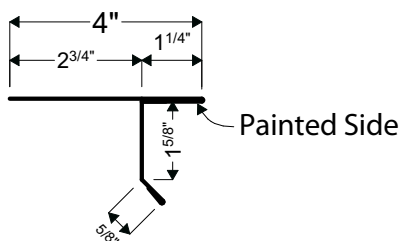

07B | STANDING SEAM EAVE

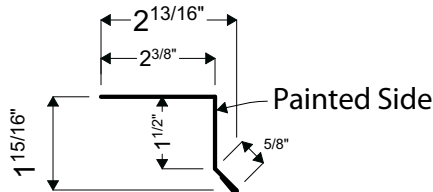

09 | DRIP EDGE

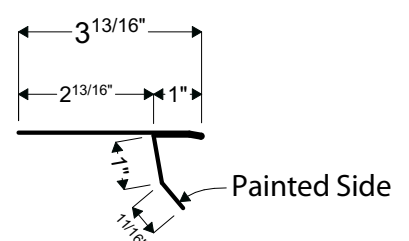

09B | DRIP EDGE B

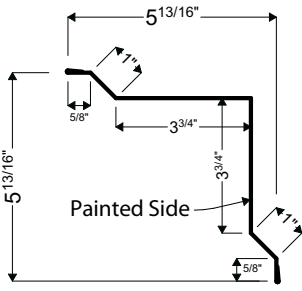

08 | INSIDE CORNER

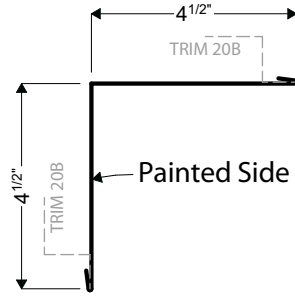

08B | ARCHITECTURAL INSIDE CORNER

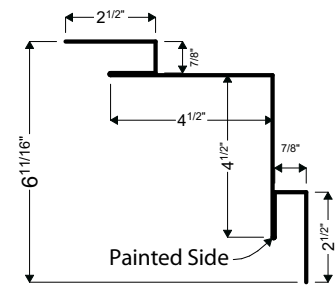

08E | TRIM FIRST INSIDE CORNER

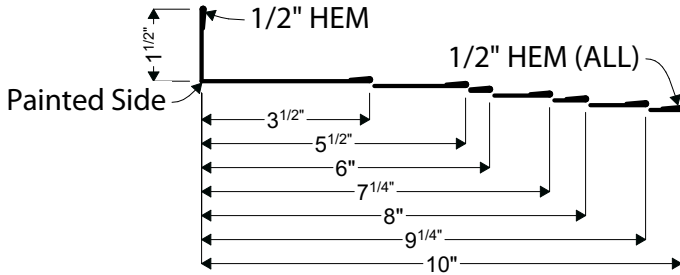

103, 105, 106, 107, 108, 109, 110 | POST TRIM

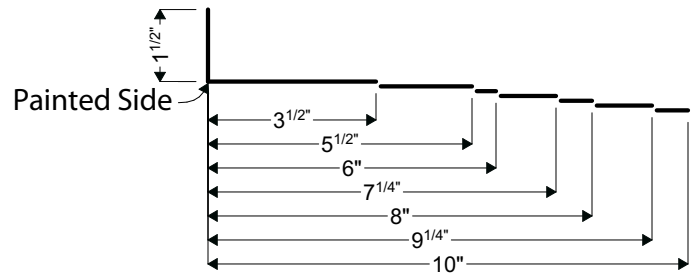

103B, 105B, 106B, 107B, 108B, 109B, 110B | POST TRIM B

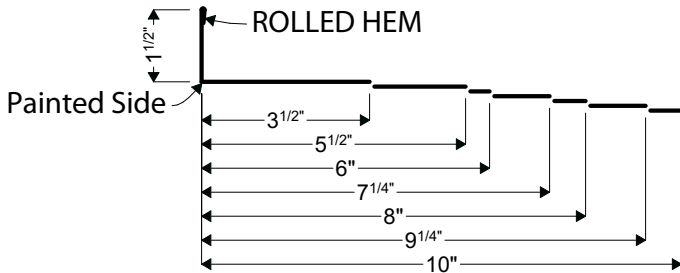

103C, 105C, 106C, 107C, 108C, 109C, 110C | PLAIN FASCIA

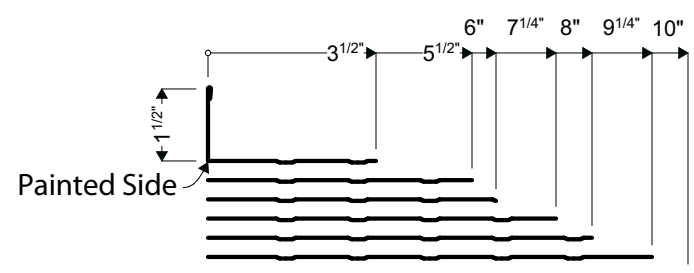

103R, 105R, 106R, 107R, 108R, 109R, 110R | RIBBED FASCIA

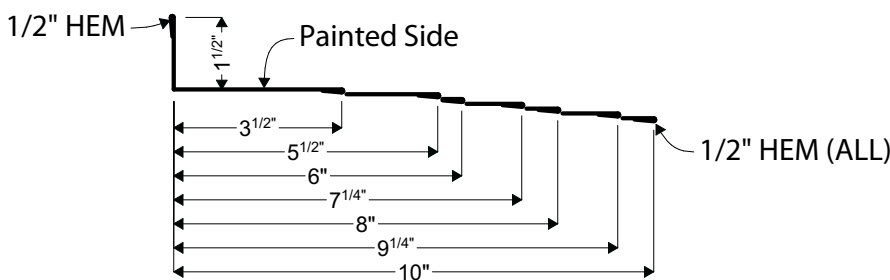

103D, 105D, 106D, 107D, 108D, 109D, 110D | INSIDE ANGLE

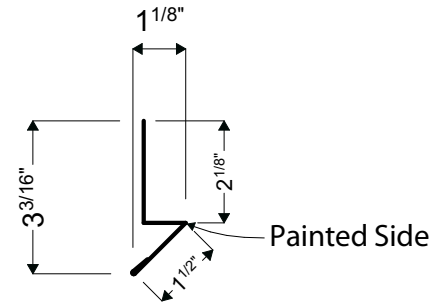

11 | RAT GUARD

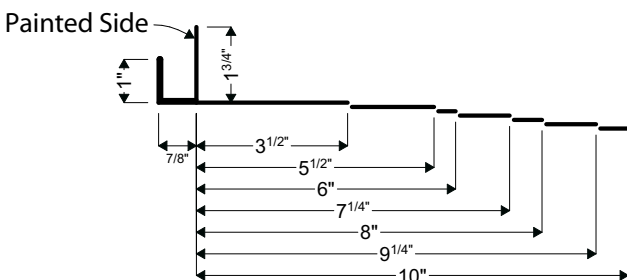

173, 175, 176, 177, 178, 179, 1710 | POST FJTRIM

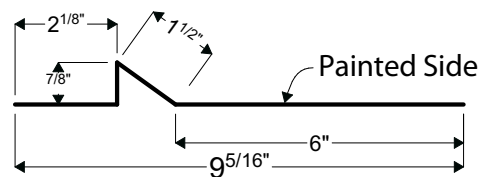

11B | FAT RAT

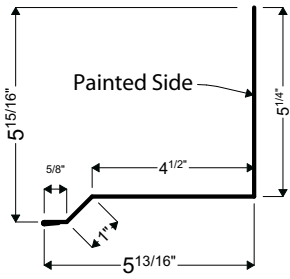

18 | ROOF TO WALL FLASHING

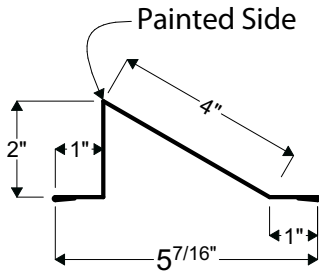

12 | SNOW GUARD

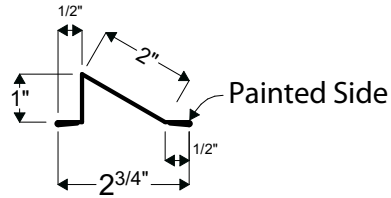

12B | MINI SNOW GUARD

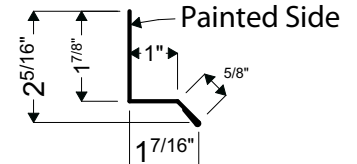

13 | L BASE TRIM

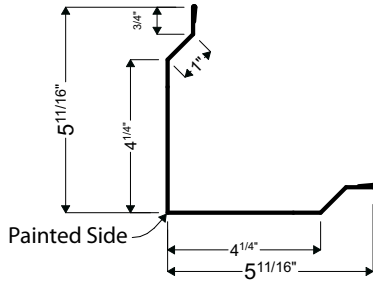

14 | OUTSIDE CORNER

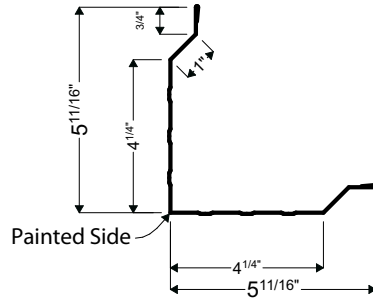

14R | OUTSIDE CORNER (RIBBED)

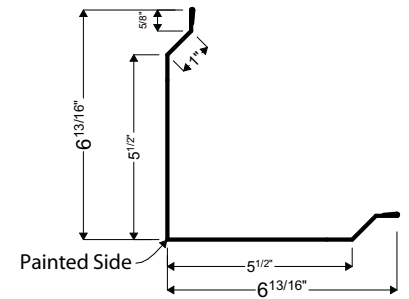

14B | OVERSIZE OUTSIDE CORNER

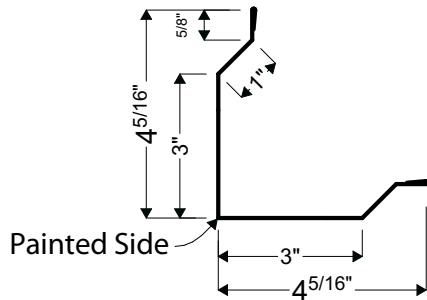

14C | MINI OUTSIDE CORNER

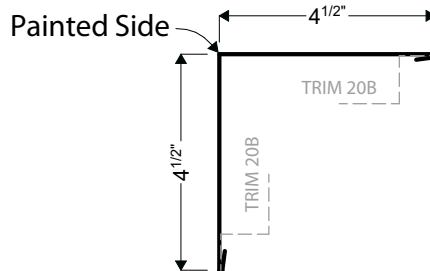

14D | ARCHITECTURAL CORNER

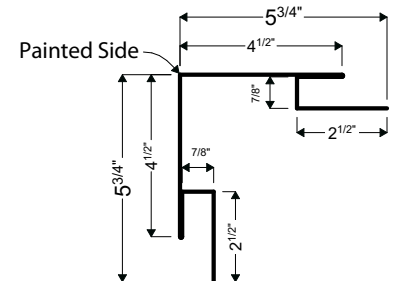

14E | TRIM FIRST OUTSIDE CORNER

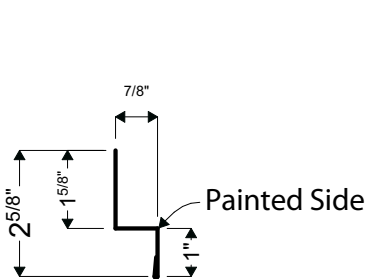

15 | WALL LITE FLASHING

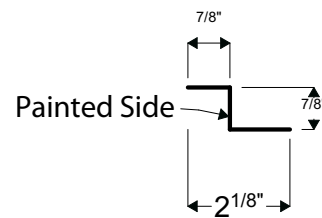

20B | Z TRIM B (TUFF-RIB; BOARD & BATTEN)

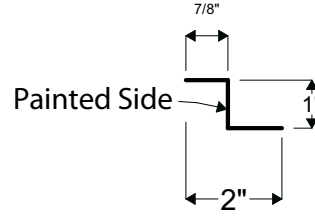

20C | Z TRIM C (SNAPLOCK 1)

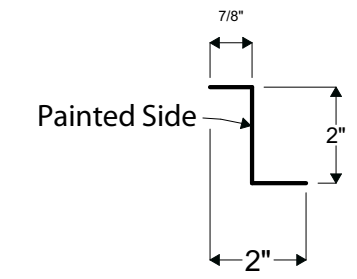

20D | Z TRIM D (STANDING SEAM)

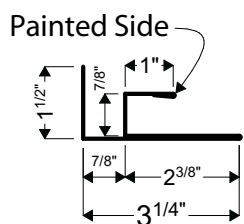

16 | FJTRIM

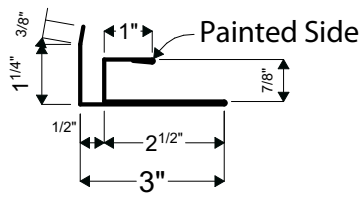

16B | MINI FJTRIM

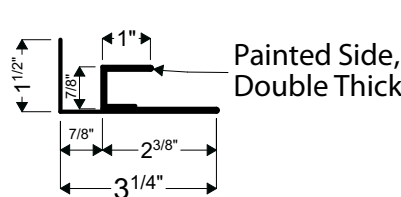

16C | FULL WRAP FJTRIM

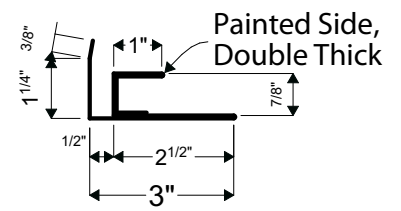

16D | FULL WRAP MINI FJTRIM

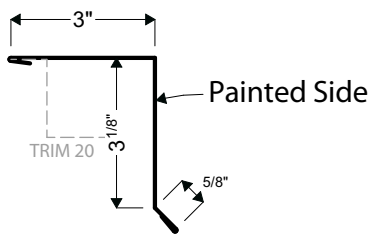

22 | ARCHITECTURAL RAKE/GABLE

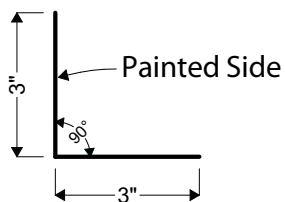

25 | UNIVERSAL FLASHING



32 | REGLET FLASHING

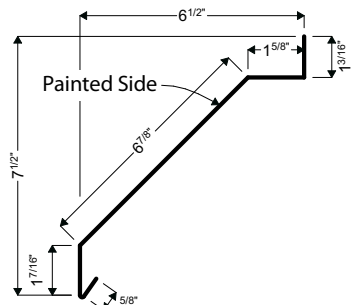

24 | TRACK COVER

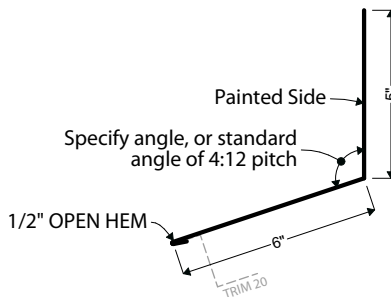

50B | STANDING SEAM ENDWALL

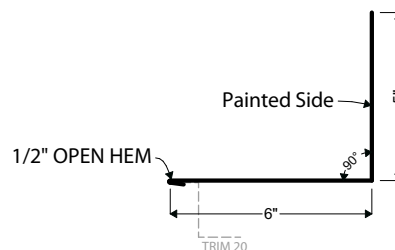

50C | STANDING SEAM SIDEWALL

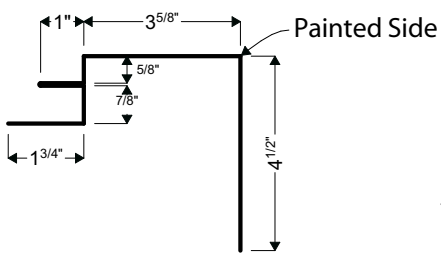

27 | ARCHITECTURAL POST & DOOR TRIM

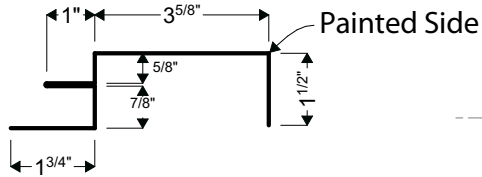

28 | ARCHITECTURAL TRIM

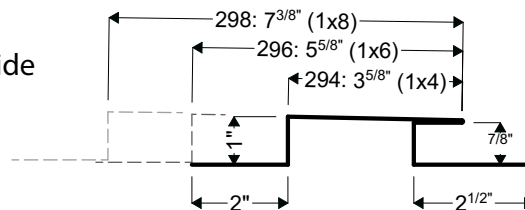

294, 296, 298 | BOARD BAND

PART A PART B

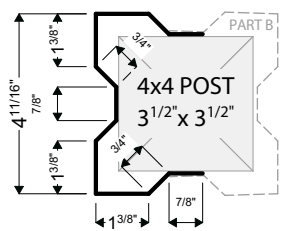

304A, 304B | 4x4 POST WRAP

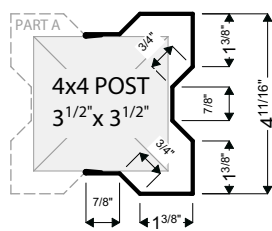

PART A PART B

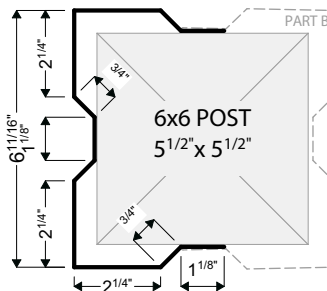

306A, 306B | 6x6 POST WRAP

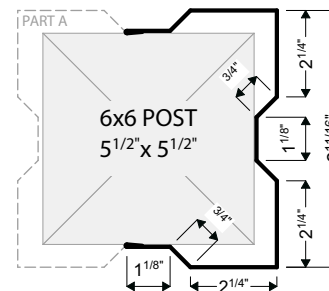

UPPER PROFILE MATCHES RIDGE CAP (01)

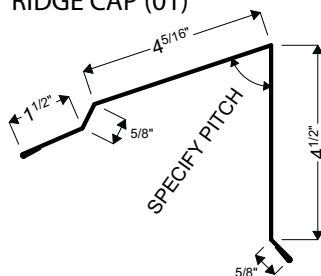

31 | PEAK FLASHING

UPPER PROFILE MATCHES ARCH'L RIDGE CAP (01B)

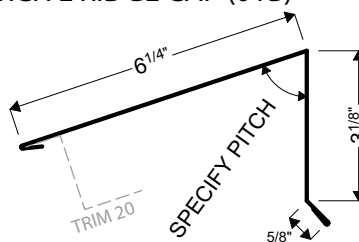

31B | ARCHITECTURAL PEAK FLASHING

UPPER PROFILE MATCHES ARCH'L RIDGE CAP (01B)

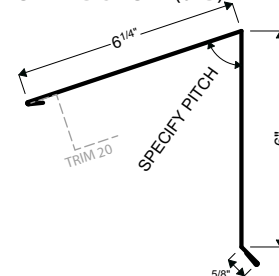

31C | JUMBO ARCH'L PEAK FLASHING



(208) 565-3002

INFO@IBEXMETAL.COM

**280 GREAT NORTHERN RD
BONNERS FERRY, ID 83805**